



OPERATION AND SAFETY MANUAL

Important Safety Information Inside

Read this manual before handling this firearm.

Keep this manual with your firearm and review it before each use. This manual is designed to fit in your shirt or jacket pocket. Do not allow others to handle or fire your firearm until they have read this manual. Transfer this manual with the firearm upon ownership change.

Be a responsible firearm owner. Use it safely, store it securely, and always transfer a firearm responsibly and legally.

CONTENTS

Read and Understand this Manual.....	3	Reassembly	26
Know Your Gun	4	Magazine Disassembly 40S&W	28
Safety Rules	5	Magazine Disassembly 9MM	29
Loaded Chamber Indicator	12	Parts Diagram	30
Striker Status Indicator.....	13	Point of Aim	34
Safety Devices.....	14	Care and Cleaning	35
Loading/ Preparing To Fire	16	Cable Lock	37
Firing	17	Disclaimer.....	38
Unloading/Clearing.....	18		
Malfunction Warning	20		
Changing Back Strap.....	22		
Field Strip	23		

If you have any questions concerning information in this manual, call Springfield's Consumer Safety Department at (309) 944-5631 for assistance.

BEFORE LOADING AND FIRING THIS FIREARM, READ AND UNDERSTAND THE INFORMATION IN THIS MANUAL.

This is an auto loading firearm. It is immediately loaded and ready to fire again after each shot until all cartridges loaded in magazine have been fired. The firearm is able to fire both with and without the magazine in place.

REMOVING THE MAGAZINE DOES NOT UNLOAD THE FIREARM NOR DOES IT ENGAGE A SAFETY. THE FIREARM IS NOT UNLOADED UNTIL THE MAGAZINE IS REMOVED AND THE CHAMBER IS EMPTY.

ABOUT YOUR OWNER'S MANUAL

This is an instruction booklet on how to operate this firearm with some basic safe handling rules. It does not attempt to provide information about using a firearm to defend yourself, how to hunt, or for competitive or target shooting. It is important to receive training from a competent firearms instructor prior to engaging in any of these activities. The National Rifle Association, your local or state authorities, or your firearm dealer may provide information regarding available instructors or training courses. If you have a license to carry concealed, never do so without prior instruction from a certified instructor. Using a firearm for self defense is a complex subject with dangers and risks for which you must be properly trained. Every safety rule has a reason behind it - read the rules carefully and understand why each is important for safety.

It is recommended that every person receive instructions from a competent firearms instructor before handling this or any other firearm.

Know and obey all firearm laws. Do not give a firearm to someone who is not allowed to own a firearm or who may use it for a criminal purpose.

Used firearms

If you purchased this firearm as a used firearm, have it inspected and tested by a competent pistolsmith before you use it. Guns are sometimes altered and may require repair before they can be used safely.

Store firearms safely in the home

Store firearms unloaded, locked and in a secure place. Obey firearm storage laws. Store firearms and ammunition separately. Because your children may be in other homes where firearms are stored, you should show them what to do if they see or find a firearm by showing them the Eddie Eagle video available from the NRA by calling (703) 267-1000.

OBEDIENCE TO ALL GUN LAWS WHEN BUYING AND SELLING FIREARMS. NEVER BUY A GUN INTENDING TO TRANSFER IT TO SOMEONE WHO IS PROHIBITED FROM OWNING FIREARMS. NEVER EVER BE A "STRAW PURCHASER."

KNOW YOUR GUN XD^M

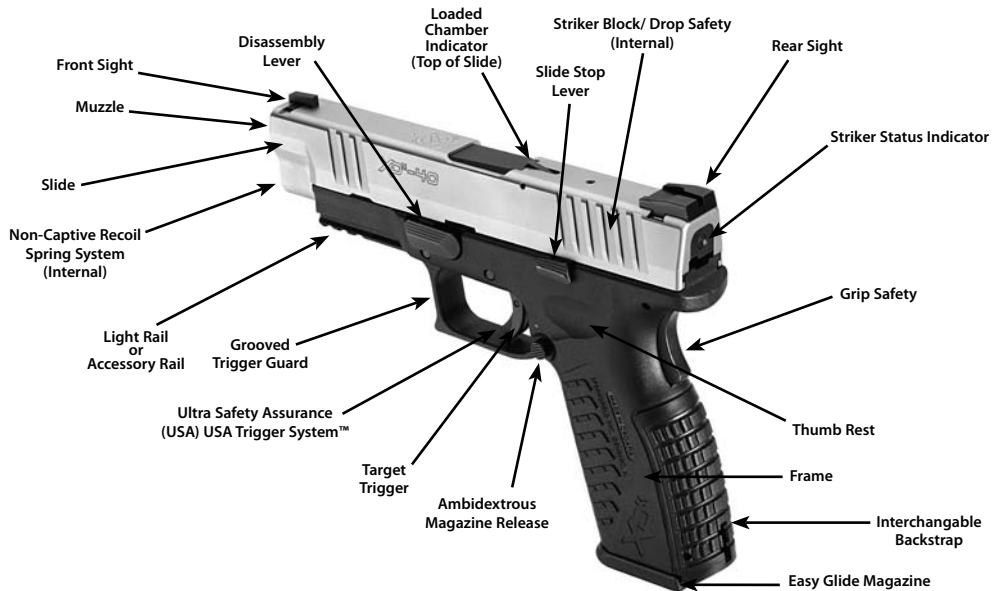

SAFETY RULES

READ AND UNDERSTAND THESE SAFETY RULES

Be A Safe Shooter.

ACCIDENT (*ak' si dent*) *N. 1. An unintentional or unexpected happening that is undesirable or unfortunate, especially one resulting in injury, damage, harm or loss.*

Don't be the cause of an accident.

A responsible firearm owner is safety minded and always handles firearms in a safe manner by following the basic rules of safe shooting and by using common sense in the handling of a firearm.

Store firearms unloaded, locked, and in a secure place. Keep keys for locks separate from lock and in a secure place away from children. Keep firearms out of reach of children. You are responsible for children's safety.

Be A Responsible Gun Owner.

- Treat all firearms as if they are loaded at all times.
- Never point a firearm at any person or thing you do not intend to shoot.
- Keep your finger off the trigger until you are on target and have made the DECISION to fire.
- Be sure you have positively identified your target.
- **ALWAYS KEEP THE MUZZLE POINTED IN A SAFE DIRECTION.**
- **Do not drop your firearm.** If it falls, it may fire. If you do drop it, unload it and examine it to be sure it works correctly. Do not attempt to fire it again until you have completed this safety check.
- Never put your hand over the muzzle of the firearm.
- Keep your finger(s) off the trigger and out of the trigger guard until you are actually aiming at your target, and made the decision to fire.
- Under no circumstances should the owner/purchaser of this firearm allow it to come into possession of or be handled by small children or a mentally handicapped individual.

TREAT EVERY GUN AS IF IT IS LOADED ... ALL THE TIME.

BE A RESPONSIBLE GUN OWNER!

- Never rely on a firearm's "safety features" to protect you from unsafe firearm handling. A safety is only a mechanical device, not a substitute for common sense.
- Keep your finger off the trigger until you are on target and have made the DECISION to fire.
- Be sure of your target and backstop before you shoot. Ask yourself what your bullet will hit if it misses or goes through the target.
- Before shooting, be sure the barrel is clear of obstructions, including excessive oil and grease.
- Do not let water, snow, mud or other materials enter the barrel.
- Do not pull a firearm toward you by the muzzle.
- Always hold your firearm so you control the direction of its muzzle in case you fall or stumble.
- **ALWAYS KEEP THE MUZZLE POINTED IN A SAFE DIRECTION.**
- If anything does get into the barrel, remove cartridges, and clean bore immediately before attempting to shoot. Obstructed barrels can burst and injure you and/or bystanders.
- Maintain possession of your firearm at all times when you are on the firing range or during target practice. **DO NOT ALLOW OTHERS TO HANDLE YOUR FIREARM UNLESS THAT PERSON IS BEING INSTRUCTED OR TRAINED.**



The **XD^M** Pistol is classified as a firearm and dangerous weapon. Injury or death to you or others may result from unsafe or improper use.

BE A SAFE SHOOTER!

- **ALWAYS KEEP THE MUZZLE POINTED IN A SAFE DIRECTION.**
- Guns and alcohol or drugs do not mix. Do not take them before or during shooting activities. Your vision, coordination and judgment could be impaired, making firearm handling unsafe.
- When taking medication, seek a doctor's advice to be sure you can operate and handle your firearm safely.
- Receive training from a competent firearms instructor before using any firearm.
- Before attempting to shoot, practice operations by dry firing without a magazine and with the chamber empty. Become familiar with the safety features, trigger control, and handling of the firearm.
- Always keep and carry your firearm with an empty chamber until you intend to shoot, so your firearm cannot be fired unintentionally.
- Firearms should be unloaded when not in use. This means both the chamber and magazine are empty.
- When transferring a firearm by hand, always open the action and check to assure that it is unloaded prior to handing it over to someone.
- Never take anyone's word that a firearm is unloaded. When receiving a firearm, always open the action and check that it is unloaded.

READ THESE RULES!

- Load firearm only when on range preparing to fire. Unload it before leaving range.
- **Treat every firearm as if it is loaded ... all the time!**
- Load and unload with the firearm muzzle pointed in a safe direction.
- Be certain firearm is unloaded before cleaning.
- Completely unload your firearm before storing.
- **Never leave a loaded firearm unattended.**
- Tragedy may result if a child finds your firearm and plays with it. Keep every firearm secure. Children do not believe firearms can kill.
- Store firearms and ammunition separately. Both should be placed beyond children's reach.
- Obey all laws regarding the storage and security of firearms in the home.
- Know and obey the laws regarding the transportation and carrying of firearms.
- Never carry any firearm in your pocket, purse or tucked in your belt or waistband. Use a firearm case or a proper holster.
- **Old or reloaded ammunition may cause damage to the firearm and/or injure you or others. Use only clean, dry, original, high-quality, commercially manufactured ammunition. Using reloaded ammunition may void the warranty.**
- **ALWAYS REMEMBER REMOVING THE MAGAZINE DOES NOT UNLOAD THE PISTOL NOR DOES IT ENGAGE A SAFETY.**
- **ALWAYS REMEMBER THE PISTOL IS NOT UNLOADED UNTIL THE MAGAZINE IS REMOVED AND THE CHAMBER IS EMPTY.**
- **ALWAYS REMEMBER THIS FIREARM IS ABLE TO FIRE WITH OR WITHOUT THE MAGAZINE IN PLACE.**

TREAT EVERY GUN AS IF IT IS LOADED ... ALL THE TIME!

- Many ammunition identifications sound similar. Make sure you use the right caliber/size ammunition in your firearm.
- If firearm fails to fire when the trigger is pulled, keep it pointed at the target for at least 30 seconds. Remove the magazine before opening the action. Remove the cartridge from the chamber. Sometimes slow primer ignition will cause a “hang fire” and the cartridge will go off after a short pause.
- When group firing, always appoint someone to maintain safety control. Obey his/her commands immediately and completely.
- While shooter is loading, firing, and unloading, spectators need to remain behind shooters.
- **Always wear protective glasses when shooting.**
- **Always wear hearing protection when shooting.**
- Never shoot at hard flat surfaces or water; bullets will ricochet unpredictably.
- Do not alter or modify your firearm.
- Have your firearm serviced regularly by a qualified pistolsmith.
- Discharging firearms in poorly ventilated areas, cleaning firearms, or handling ammunition may result in exposure to lead and other substances known to cause birth defects, reproductive harm, cancer and other serious physical injury. Have adequate ventilation at all times. Wash hands thoroughly after firing your firearm, after cleaning your firearm, or whenever you have handled ammunition.
- Always use quality ammunition.
- **ALWAYS KEEP THE MUZZLE POINTED IN A SAFE DIRECTION.**



Safety and instruction manuals are available from Springfield, Inc.



Always wear eye and ear protection when using any firearm.

BE A SAFE SHOOTER!

- Do not try to change your firearm's trigger pull, because alterations of trigger pull usually affect sear engagement and might cause accidental firing.
- Never use a firearm that jams or fails to function properly. Should this occur, return to Springfield, Inc. for warranty/repair.
- If your shot sounds weak or underpowered, it could mean a bullet is in the chamber/bore. The gun should be immediately unloaded and the chamber/bore checked for obstructions before refiring.
- **DO NOT "HORSEPLAY"** with a firearm. Your firearm cannot think ...but you can. Firearm safety depends on you.

IMPORTANT WARNING

There is no safe way to discharge a firearm in a home or apartment. Bullets will go through walls, floors, furniture, and appliances and still cause serious injury or death to persons in the house, next-door, or outside. Accidental discharges indoors ALWAYS result in property damage or personal injury.



WARNING: When you squeeze the trigger, you must expect the firearm to fire. You must take full responsibility for firing it. Your care can avoid accidental discharge and thereby avoid accidental injury and death.

HANDLING

We want you to be a safe, satisfied shooter.

Before attempting to load this firearm with live ammunition, follow the sequence of operations shown here without ammunition or with dummy rounds.

By practicing operations without ammunition (or with dummy rounds), you will become familiar with:

- Safety features,
- Trigger control (dry firing),
- Handling of your firearm.

As a result you will be a safer, more confident shooter when aiming at your first target.



WARNING: When you squeeze the trigger, you must expect the firearm to fire. You must take full responsibility for firing it. Your care can avoid accidental discharge and thereby avoid accidental injury and death.

Write or call us concerning any items you do not understand and/or which might relate to your safety and the safe operations of any of our products.

Springfield, Inc.
Consumer Safety Department
420 West Main Street
Geneseo, IL 61254
(309) 944-5631



Safety and instruction manuals are available from Springfield, Inc.

LOADED CHAMBER INDICATOR

Your **XP**[™] firearm has a loaded chamber indicator (See Figure 12-1). The indicator allows you to observe whether a cartridge is in the chamber. When a cartridge is in the chamber the indicator raises above the barrel (See Figure 12-2). **When the loaded chamber indicator is up, the firearm is ready to fire.**

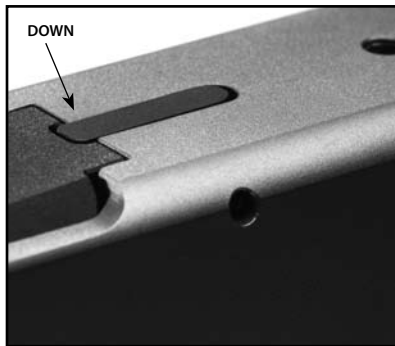

Figure 12-1

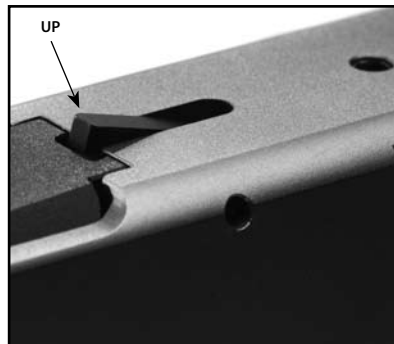

Figure 12-2



Warning! *Even though the chamber is empty there may be cartridges in the magazine. The firearm is not completely unloaded until the magazine is removed and the chamber is empty.*



Never trust a safety. *Always assume the firearm is loaded.*

STRIKER STATUS INDICATOR

Your **XD**™ firearm has a cocking indicator in the rear of the slide (See Figure 13-1). When the firearm is cocked, the pin will protrude out of the rear of the slide (See Figure 13-2). (The cocking indicator does not always mean that the firearm is loaded). However, when the pin is out, always treat the firearm as if it is loaded. Only the Loaded Chamber Indicator will show if the firearm is loaded (See Page 12).



Never rely on a safety. Always assume the firearm is loaded.



Figure 13-1



Figure 13-2

SAFETY DEVICES

- 1. Trigger Safety** - The trigger safety blocks the trigger from moving backward. A lever incorporated into the trigger (See Figure 14-1) deactivates the safety when completely depressed while pulling the trigger. The trigger can only be pulled if depressed together with the trigger safety lever (See Figure 14-2) and the grip safety is deactivated.

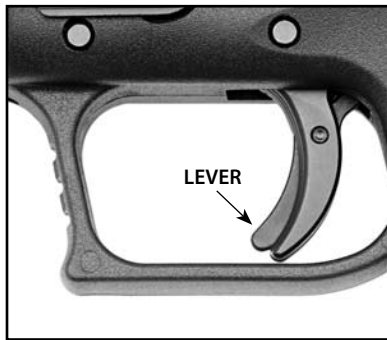

Figure 14-1

NOTE: DEPRESSING THE TRIGGER SAFETY AND PULLING THE TRIGGER WILL NOT ALLOW THE FIREARM TO FIRE UNLESS THE GRIP SAFETY IS DEPRESSED (SEE PAGE 15).



Figure 14-2



Safety devices, like all things mechanical, can fail. Safety devices are not a substitute for safe firearm handling. Always follow the rules for safe firearm handling.

SAFETY DEVICES

2. **Grip Safety** - The grip safety is located at the top rear of the firearm grip (See Figure 15-1). The grip safety must be depressed to be deactivated. Unless the grip safety is properly depressed and deactivated, the firearm will not fire even if the trigger is pulled. Grip safety must also be depressed to allow slide to be pulled to the rear. The grip safety is designed to be deactivated when the firearm is properly gripped to fire (See Figure 15-2). To fire the firearm you must properly hold the firearm, and depress the grip safety,



Figure 15-1

and then put your finger on the trigger to depress the trigger safety and pull the trigger.



Figure 15-2

3. **Striker Block Safety** - As an added safety feature, an internal striker block will prevent the firearm from firing until the grip safety is depressed and the trigger is pulled.

LOADING/PREPARING TO FIRE

1. Place the EMPTY magazine in the magazine well, located in bottom of firearm grip. Push firmly enough on bottom of magazine to make sure it is properly seated. A distinctive “click” will confirm the magazine has been properly inserted. Pull the slide completely to the rear until it locks back.
2. Depress magazine release and remove magazine.
3. Ensure that you are using the proper caliber ammunition for your firearm. Place rim of first cartridge on front of follower (See Figure 16) then push the cartridge down on the follower and slide the cartridge under the lips of the magazine completely to the rear. Load successive rounds by pushing cartridge down on previously loaded cartridge. Use only clean, dry, original, high-quality, commercially manufactured ammunition. Using reloaded ammunition may void warranty.
4. **POINT FIREARM IN A SAFE DIRECTION AND KEEP FINGER OFF TRIGGER.** Re-insert magazine into magazine well, located in bottom of firearm grip. Push firmly enough on bottom of magazine to make sure it is properly seated.



Caution: Do not slam or forcefully jam magazine into magazine well.

5. Depress the slide stop lever to allow slide to move forward and load a shell from the magazine into the chamber.
6. The loaded chamber indicator will be in the up position (See Figure 12-2).
7. The striker status indicator will be protruding out of the rear of the slide (See Page 13) in the “cocked” position.



Caution: The firearm is now ready to fire.



Figure 16



WARNING

Never touch the trigger when loading or unloading the firearm.

FIRING

If you have never fired a firearm before, practice without live ammunition before your first shot. Then load only **one** cartridge into the magazine for your first live ammunition firing.

1. **POINT FIREARM IN A SAFE DIRECTION WHILE KEEPING YOUR FINGER OFF OF THE TRIGGER.**
2. Load cartridge into chamber from magazine following the procedure described on page 16.
3. Grasp grip of firearm firmly. (A loose grip may cause the firearm to malfunction.) The pressure from the hand will deactivate grip safety located at top of rear grip area.
CAUTION: THE FIREARM IS NOW READY TO FIRE. BE PREPARED FOR NOISE AND RECOIL WHEN FIREARM FIRES.
4. Aim firearm at target by aligning sights.



Always wear eye and ear protection when using any firearm.



Safety and instruction manuals are available from Springfield, Inc.

Point firearm in a safe direction at all times.

5. Now lightly place finger on trigger, and slowly squeeze trigger to fire the firearm. Spent cartridge is expelled up and to the right.
6. Pistol will automatically be ready to fire again after each shot until all cartridges loaded in magazine have been fired.
7. When last cartridge has been fired, slide will lock open and remain to rear.

This is an auto loading firearm. It is immediately loaded and ready to fire again after each shot until all cartridges loaded in magazine have been fired. The firearm is able to fire both with and without the magazine in place. **REMOVING THE MAGAZINE DOES NOT UNLOAD THIS FIREARM NOR DOES IT ENGAGE A SAFETY. THIS FIREARM IS NOT UNLOADED UNTIL THE MAGAZINE IS REMOVED AND THE CHAMBER IS EMPTY.**



WARNING: Improperly loading the **XDSM** by manually inserting a round in the chamber is improper and may cause accidental discharge and possible damage to the extractor. Always load the firearm using the magazine. When loading the firearm, always point the muzzle in a safe direction.

UNLOADING/CLEARING

If slide is already in “locked back” position: (See Figure 18).

1. **POINT FIREARM IN SAFE DIRECTION WHILE KEEPING YOUR FINGER OFF OF THE TRIGGER.**
2. Press magazine release button to remove magazine.
3. From above and rear, carefully inspect chamber to make sure it is empty.

When magazine has been removed and when chamber is empty, a firearm lock can be installed (See Page 37). Pistol can now be safely stored in a secure place.

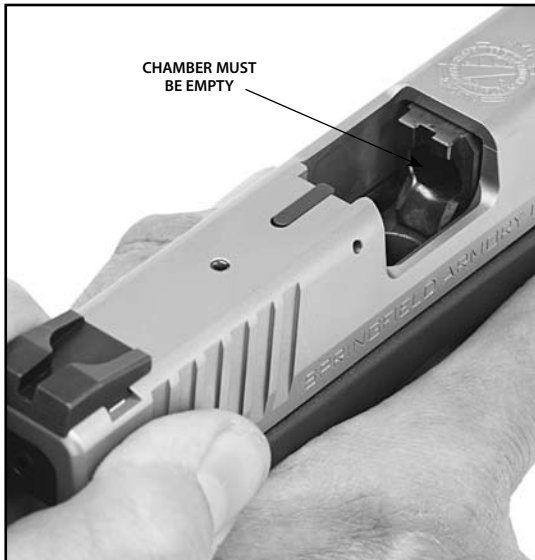

Figure 18



Pistol is not empty or unloaded until the magazine is removed and the chamber is empty. To properly clear a firearm, remove the magazine, then pull slide back and check the chamber.

UNLOADING/CLEARING

If slide is forward:

1. **POINT FIREARM IN SAFE DIRECTION WHILE KEEPING YOUR FINGER OFF OF THE TRIGGER.**
2. Press magazine release button to remove magazine.
3. Fully depress the grip safety and pull slide fully to rear to eject any cartridge remaining in chamber.

NOTE: GRIP SAFETY MUST BE DEACTIVATED TO ALLOW THE SLIDE TO BE PULLED TO ITS REARWARD (OPEN) POSITION.

4. While holding slide in rearward (open) position, carefully inspect chamber making sure it is empty (See Figure 19).

When magazine has been removed and when chamber is empty, a firearm lock can be installed (See Page 37). Pistol can now be safely stored in a secure place.

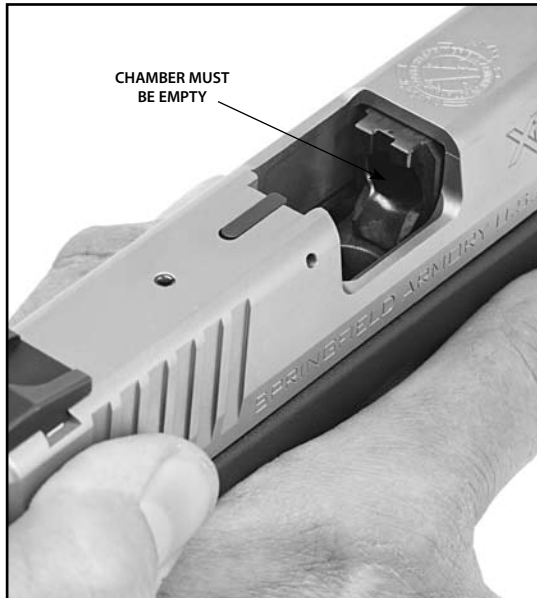

Figure 19



WARNING

Pistol is not empty or unloaded until the magazine is removed and the chamber is empty. Never touch the trigger when loading or unloading the firearm.

MALFUNCTION WARNING!

If cartridge hangs up, jams or binds when being chambered from magazine into chamber, do not attempt to force it into the chamber by pushing or striking slide.

1. What to do:
 - **Point firearm in a safe direction while keeping your finger off of the trigger.**
 - Remove magazine.
 - Pull back on slide and allow cartridge to fall from firearm.
 - If cartridge does not fall free, pull slide back and lock it back.
 - Carefully dislodge cartridge.
 - If cartridge cannot be removed, lock slide back, carefully store your firearm and magazines and take it to a pistolsmith. (USE SUPPLIED CABLE LOCK). (See Figure 20 & Page 37)
2. Most failures to feed or chamber a cartridge are the result of a damaged magazine, improper firearm handling or defective ammunition.



Safety and instruction manuals are available from Springfield, Inc.



Always have firearm pointed in a safe direction.
Failure to obey safety information may result in injury to you or others.

3. Whatever the cause, a jammed cartridge can be a dangerous situation.

If you have any questions concerning information in this manual, call Springfield's Consumer Safety Department at (309) 944-5631 for assistance.

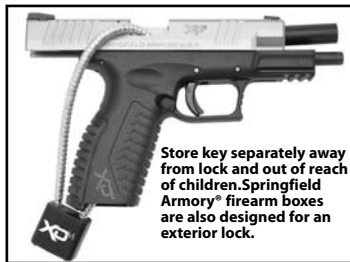





Figure 20



Always wear eye and ear protection when using any firearm.

TO ELIMINATE MALFUNCTIONS

- First try changing type/brand of ammunition and/or magazine.
- If changing to another type/brand of ammunition and/or magazine does not at once result in smooth feeding of cartridges from magazine to chamber, the following steps should be taken:
 - Make certain chamber and magazine are unloaded. Magazine should be removed first. Check chamber to be sure it and magazine well are clear of cartridges.
 - Thoroughly clean magazine, paying particular attention to removing accumulated residue.
 - Thoroughly clean breech mechanism of firearm. Use a bristle brush and solvent to remove residue and fouling from breech face, extractor, chamber and feed ramp. (See **CARE AND CLEANING** section for detailed instruction).
- Check that magazine spring tension is adequate; the spring should hold the follower tightly against the lips of the magazine.
- Check that magazine lips are free of nicks and burrs and are not deformed.
- Remove excess oil and solvent from all cleaned components, load magazine and try firearm again.
 -  **WARNING** An obstructed, cracked or damaged barrel should never be used and the firearm should be returned to Springfield for inspection.
- Some high-capacity non-Springfield magazines can be modified to fit the .
 -  **WARNING** Many of these modified magazines may break the ejector if forcibly inserted. Such modified magazines should not be used.

CHANGING BACK STRAP XDP^M



Warning: Make sure the firearm is completely unloaded, magazine removed and chamber clear.

REMOVAL

- Carefully remove the back strap/lanyard roll pin by using a 3/32 pinch, drifting the pin out. (DO NOT FORCE THE TAPERED SHAFT OF THE PINCH INTO THE HOLE) (See Figure 22-1).
- Grip bottom of back strap, lift up and away from grip (See Figure 22-2).

Note: Use a flat sturdy platform. Make sure holes are aligned correctly.

INSTALLATION

- Starting at 45 degree angle from grip, insert upper portion of back strap into the frame. Rotate downward and install pin. (DO NOT FORCE THE TAPERED SHAFT OF THE PINCH INTO THE HOLE) (See Figure 22-3).



Figure 22-1



Figure 22-2



Figure 22-3

FIELD STRIP XD^M

NOTE: FIELD STRIPPING PROCEDURES ON THE XD(M)TM ARE THE SAME REGARDLESS OF CALIBER.

Before performing any cleaning or maintenance, make sure the firearm is completely unloaded (this includes the magazine and chamber). Wear eye protection.

ALWAYS REMEMBER THE FIREARM IS ABLE TO FIRE WITH OR WITHOUT THE MAGAZINE IN PLACE.

1. POINT GUN IN SAFE DIRECTION.
2. Remove magazine and unload firearm.
3. Draw back the slide to the rear stop position and lock it open, pushing up the slide stop lever (See Figure 23-1).
4. Visually inspect the chamber to confirm the firearm is unloaded.
5. Rotate the disassembly lever clockwise to a vertical 12 o'clock position (See Figure 23-2).



Figure 23-1



Figure 23-2



If you decide to disassemble your Springfield Armory® firearm, do so properly. Improper disassembly and/or assembly will create unsafe conditions that could result in injury or death, or a firearm that simply will not work. Don't take chances. Do not attempt to disassemble this or any other firearm until you have received training and instructions from a competent pistolsmith.

FIELD STRIP XD^M

Before performing any disassembly, point firearm in safe direction, make sure the firearm is completely unloaded (this includes the magazine and chamber). Wear eye protection.

6. Firmly grip slide and pull to the rear to release the slide stop lever (See Figure 24-1). Maintain firm grip on slide and allow the slide to slowly move forward until the spring tension is released.

 **Caution: Remember slide is under spring tension, maintain control.**

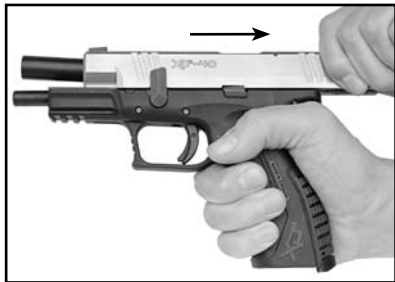

Figure 24-1

7. Move the complete slide assembly forward and off the frame (See Figure 24-2).



Figure 24-2

FIELD STRIP XD^M

8. Remove the recoil system from the slide (4.5" See Figure 25-1)(3.8" See Figure 25-2).

 **Caution: The 4.5" is a Non-Captive Recoil Spring System. Spring is under tension. Maintain control.**

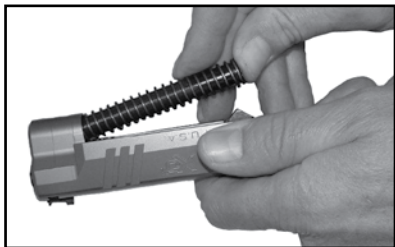

Figure 25-1

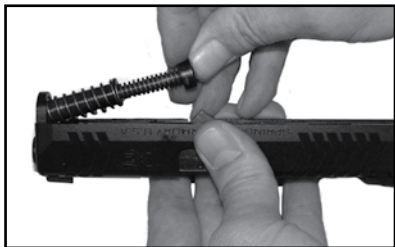

Figure 25-2

9. Remove the barrel from the slide (See Figure 25-3).

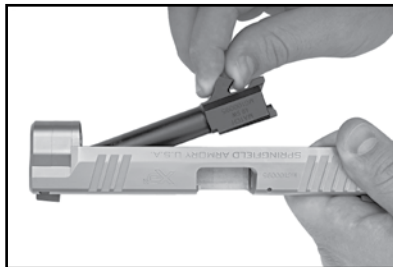

Figure 25-3

The firearm is now fully field stripped and ready for cleaning.



Further dismantling is not necessary and should only be done by Springfield, Inc. or a qualified pistolsmith.



Safety and instruction manuals are available from Springfield, Inc.



Always wear eye and ear protection when using any firearm.

REASSEMBLY XD^M

NOTE: REASSEMBLY PROCEDURES ON THE XD(M)[™] ARE THE SAME REGARDLESS OF CALIBER.

 **Caution: Never allow live ammunition in the area while you are maintaining your firearms.**

1. Install barrel into slide (See Figure 26-1) insuring that the top of the chamber of the barrel is flush with the top of the slide (See Figure 26-2).
2. Reinstall the recoil system insuring it is properly aligned (4.5" - See Figure 26-3)(3.8" - See Figure 26-4).



Figure 26-1



Figure 26-2



Figure 26-3



Figure 26-4



Figure 26-5

NOTE: IMPROPERLY ALIGNED RECOIL SYSTEM OR BARREL POSITION WILL CAUSE REASSEMBLY PROBLEMS. NEVER FORCE SLIDE ASSEMBLY ONTO FRAME.

3. Install the slide assembly onto the frame (See Figure 26-5).

REASSEMBLY XD^M

 **Caution: Never allow live ammunition in the area while you are maintaining your firearms.**

If interference is encountered, remove the slide assembly and make sure the barrel is properly seated and the recoil system is properly aligned.

NEVER FORCE SLIDE ASSEMBLY ONTO FRAME!
Doing so could cause damage to your firearm.

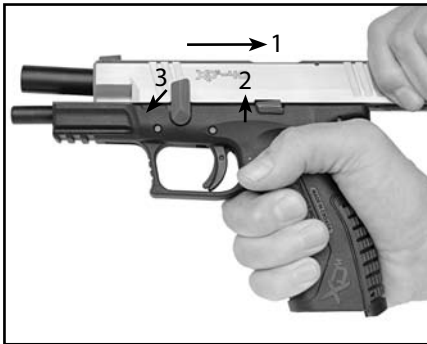

Figure 27

4. (See Figure 27) Move the slide to its most rearward position (1) (at this point spring resistance will be encountered) and move/push the slide stop up (2), locking the slide to the rear.
5. Rotate the disassembly lever counter-clockwise to the normal (locked) position (3).
6. Lower the slide.
7. Reassembly is now complete.

MAGAZINE DISASSEMBLY (40S&W)

Disassembling and cleaning magazines every 3-4 months is normally sufficient, unless the magazines have been exposed to dirt or other adverse conditions or inspection indicates a need for cleaning.

Disassembly of the **XP** magazine is accomplished by depressing the magazine locking plate and sliding the floor plate forward. (See pages 30-33 for parts nomenclature).

ALWAYS WEAR PROTECTIVE SAFETY GLASSES WHEN DISASSEMBLING OR REASSEMBLING ANY MAGAZINE.

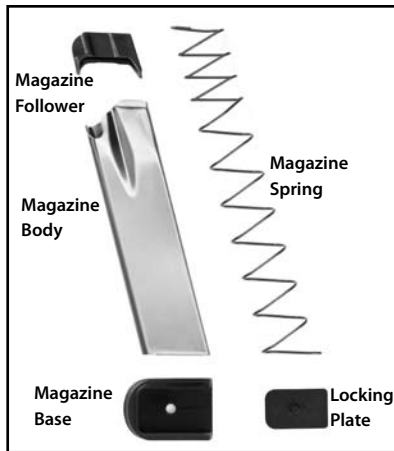

Figure 28



The magazine spring, follower, and inner floor plate are under spring tension, and can cause eye injury if not controlled during removal. Wear protective safety glasses to reduce the risk of eye injuries. Be sure to maintain downward pressure on the magazine spring, with your thumb, while disassembling.

MAGAZINE DISASSEMBLY (9MM)

Disassembly of the **XP** magazine is accomplished by depressing the exposed portion of the magazine spring that is visible through the bottom surface of the magazine base. While depressing the spring carefully slide the magazine base forward bearing in mind that there is considerable spring pressure bearing on the magazine base. Control this spring as the base is removed. The magazine can now be fully disassembled.

Reassembly: Orient and reassemble the components as illustrated in figure 29. Depress the magazine spring and slide the magazine base home until the magazine spring "snaps" into place in the base securing the magazine base.

ALWAYS WEAR PROTECTIVE SAFETY GLASSES WHEN DISASSEMBLING OR REASSEMBLING ANY MAGAZINE.

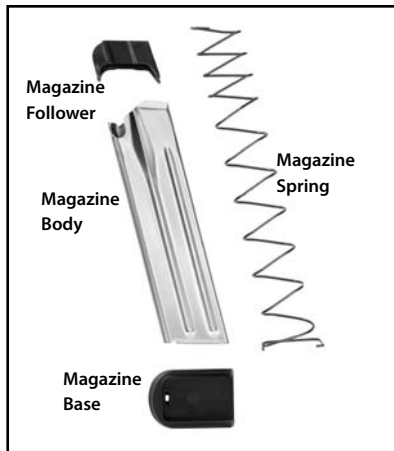

Figure 29



WARNING

The magazine spring, follower, and inner floor plate are under spring tension, and can cause eye injury if not controlled during removal. Wear protective safety glasses to reduce the risk of eye injuries. Be sure to maintain downward pressure on the magazine spring, with your thumb, while disassembling.

FRAME PARTS LIST (9MM/40S&W)

- | | |
|--|------------------------------------|
| 1 Receiver | 21 Magazine Catch |
| 4 Locking Block | 22 Magazine Catch Pin |
| 5 Locking Block Pin/Trigger pin-2 | 23 Magazine Catch Spring |
| 6 Locking Block Pin/Trigger Pin Retainer-2 | 24 Magazine Release Button |
| 7 Trigger with Safety | 25 Striker Safety Lever |
| 8 Trigger Bar | 43 Magazine Body |
| 9 Trigger Bar Spring | 44 Magazine Spring |
| 10 Sear | 45 Magazine Follower |
| 11 Sear Pin | 46 Magazine Locking Plate |
| 12 Ejector Pin | 47 Magazine Base |
| 13 Sear Spring | 48 Backstrap - 1 |
| 14 Ejector | 49 Backstrap - 2 |
| 15 Grip Safety | 50 Backstrap - 3 |
| 16 Grip Safety Pin | 51 Backstrap/Lanyard Loop Roll Pin |
| 17 Grip Safety Spring | 52 Disassembly Bar |
| 18 Slide Stop Lever | 53 Disassembler |
| 19 Slide Stop Lever Spring | 54 Disassembly Lever Spring |
| 20 Disassembly Lever | 55 Striker Safety Lever Spring |

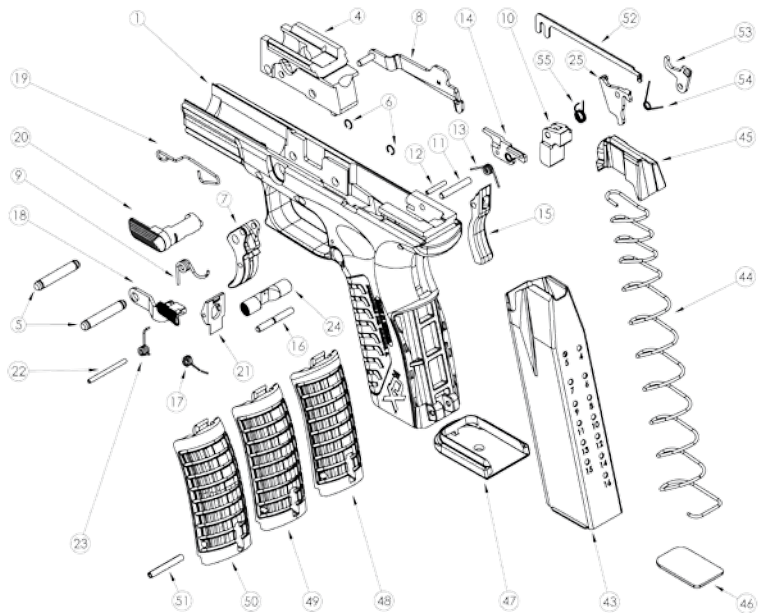

SLIDE PARTS LIST (9MM/40S&W)

- | | | | |
|----|--------------------------|----|--|
| 2 | Slide | 35 | Striker Retainer Pin |
| 3 | Barrel | 36 | Extractor |
| 26 | Striker Safety Pin | 37 | Loaded Chamber Indicator |
| 27 | Striker Locking Plate | 38 | Loaded Chamber Indicator Pin |
| 28 | Striker Spring Guide | 39 | Loaded Chamber Indicator Spring |
| 29 | Striker Status Indicator | 40 | Rear Sight |
| 30 | Striker Dampening Spring | 41 | Front Sight |
| 31 | Striker | 42 | Recoil Spring |
| 32 | Striker Spring | 43 | Recoil Spring Guide Rod |
| 33 | Striker Safety | 44 | Recoil Spring Assembly (Captive Style On 3.8" Model) |
| 34 | Striker Safety Spring | | |

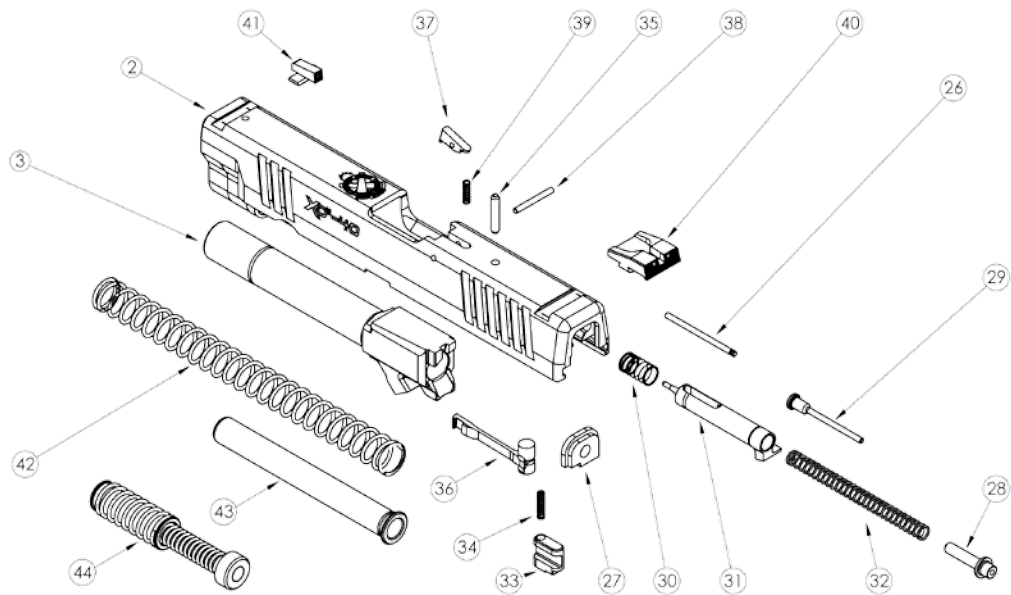

POINT OF AIM

Point of Impact

Shooters may use a “point of aim” sight picture at 25 yards (See Figure 34-1). This means that, at 25 yards, the bullet should impact the target at the point visible at the top of the front sight. Springfield, Inc. firearms are regulated to shoot point of aim, point of impact. Changing brand or type of ammunition may alter point of impact as well as shooter's technique.



Caution: Use only clean, dry, original, high-quality, commercially manufactured ammunition.

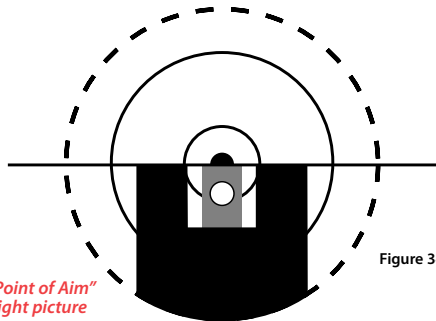

Figure 34-1

CARE & CLEANING

KEEP YOUR GUN CLEAN AT ALL TIMES

Basic materials needed:

- Cleaning rod of proper size with bristle bore brushes (fiber or brass) and tip into which cleaning patch can be inserted.
- Cloth patches
- Powder solvent
- Lubricating oil
- Small lint-free cloths for wiping and oiling
- Bristle brush for scrubbing dirt off breech face, extractor, magazine lips, follower, etc.

Use proper size bore brushes and patches - if they are too small they won't do the job, and if they are too large they will bind inside bore.

When possible, insert cleaning rod from chamber end of barrel and push rod all the way through so it emerges from muzzle.

Do not "reverse" rod direction when patch or brush is in barrel, it might bind.

Do not use patches dripping with solvent or oil. Wet patches or brushes, then squeeze out excess before using.

When using bore brushes or a larger bristle brush on breech face, breech areas, magazines, etc., work carefully to prevent damaging components.

NOTE: *If lower parts of receiver and its mechanism are especially dirty, soak in appropriate solvent, flush clean with clean solvent. Make certain that all foreign matter is removed after cleaning. Lightly oil after cleaning.*

Only a very small amount of oil is needed to adequately lubricate moving parts and prevent rust. Accumulation of oil tends to attract dust and dirt which interferes with the safe and reliable functioning of firearm. DO NOT APPLY EXCESS LUBRICATING OIL. DO NOT APPLY OIL OR GREASE TO STRIKER.



Safety and instruction manuals are available from Springfield, Inc.



Wear eye protection when using solvent. Thoroughly wash your hands to remove powder and solvents after cleaning your firearm.



Always wear eye and ear protection when using any firearm.

CLEANING PISTOL

1. Point firearm in safe direction.
2. Remove magazine and empty chamber.
3. Separate cartridges from firearm before cleaning operation.
4. Open slide and visually check that chamber and magazine well are free of cartridges.
5. Disassemble firearm as described in the **DISASSEMBLY** section.
6. Using cleaning rod, run solvent-wetted patch through barrel several times.
7. Attach solvent-wetted bristle brush to rod and run back and forth full length of barrel as needed until clean of residue.
8. Clean barrel with dry patches and examine it. If necessary, repeat barrel scrubbing. Barrel fouling can contribute to reduced accuracy, and residue accumulation in the chamber can interfere with proper feeding of cartridges from magazine.
9. Using powder solvent on a clean patch, remove powder residue from all components of mechanism. If residue cannot be removed by wiping with patch, use solvent-wetted bristle brush.
10. Next, wipe scrubbed areas with solvent-wetted patch.
11. After cleaning, run dry patch through barrel, then follow with lightly oiled patch.
12. Wipe all surfaces clean with cloth, then wipe all surfaces with lightly oiled patch (or cloth).
13. Reassemble firearm. Remember, an improperly assembled firearm is dangerous and should not be fired. Always consult a qualified pistolsmith if you experience any difficulty or have any questions concerning assembly procedure.
14. If firearm is to be stored for an extended period, final oil applications can be heavier so there will be less tendency for it to evaporate.
15. Keep your firearm clean at all times.

CABLE LOCK

Step 1 - Point gun in safe direction while keeping your finger off the trigger.

Step 2 - Press magazine release and remove magazine.

Step 3 - Pull slide fully the rear and lock open.

Step 4 - Check to see that no cartridge is in the chamber.

Step 5 - Insert cable through the ejection port and out magazine well.

Step 6 - Lock cable into cable lock.

Step 7 - Grasp slide and ease forward.

 **CAUTION: GUNS SHOULD ALWAYS BE LOCKED AND STORED IN COMPLETE COMPLIANCE WITH ALL APPLICABLE LAWS AND REGULATIONS.**

This cable lock is supplied as an aid to your security measures. Figure 37



SPRINGFIELD ARMORY®

LIMITED LIFETIME WARRANTY

Springfield, Inc. warrants to the initial retail purchaser that Springfield products will be free of defects in workmanship or material for the lifetime of the initial retail purchaser. If the initial retail purchaser gives prompt written notice to Springfield of a defect, along with proof of purchase, Springfield shall have the option to repair any defective parts or replace the products, F.O.B. factory. The customer must comply with instructions for return of parts or products. Springfield reserves the right to use new or functionally equivalent reconditioned / refurbished / pre-owned parts or products. Correction of the condition in this manner shall constitute fulfillment of all obligations of Springfield under this limited lifetime warranty. Products deemed to be in unsafe condition will not be returned to the owner. This warranty does not cover any condition determined by Springfield to have been caused by unauthorized repairs or modifications, carelessness, negligence, misuse, normal wear and tear, or failure to properly store, use or maintain the product. The foregoing warranty is exclusive and is in lieu of all or any other warranties, written or oral, expressed or implied. This limited warranty applies only to products shipped by Springfield on or after January 1, 2004. Technical specifications may be altered without notice.

Springfield, Inc. makes no warranty of merchantability or fitness for particular purpose, and Springfield shall have no liability for incidental or consequential damages.

DISCLAIMER OF LIABILITY

Springfield, Inc., disclaims any liability for personal injury, property damage or economic loss caused in whole or in part by hand loaded, reloaded, remanufactured or defective ammunition. Under no circumstances will Springfield, Inc. be liable for personal injury, property damage or economic loss resulting from unsafe handling of the firearm, or unauthorized modifications of the firearm. This warranty and disclaimer is subject to all applicable laws, some of which may limit its terms.

Exclusion for Tritium Night Sights

Springfield, Inc. does not warrant Tritium Night Sight. Manufacture should be notified for warranty.



The **XP^M** Pistol is classified as a firearm and dangerous weapon. Injury or death to you or others may result from unsafe or improper use.



Always wear eye and ear protection when using any firearm.



Safety and instruction manuals are available from
Springfield, Inc.



SPRINGFIELD ARMORY® • 420 WEST MAIN STREET, GENESEO, IL 61254 • 800-680-6866